

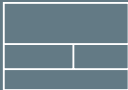







The complete range
of **TECE** push plates

TECE:
Intelligent housing technology

Contents

	TECEsquare	Page 4-9
	TECEloop	Page 10-19
	TECEplanus	Page 20-23
	TECEambia	Page 24-27
	TECEbase	Page 28-29
	Flush handles	Page 30-33
	There's a system behind it – flushing technology from TECE.	Page 34
	Flush-mounted installation	Page 35
	The technology behind ...	Page 36

There's a system behind it – flushing technology from TECE.

A collection of exclusive push plates only for the TECE cisterns. A broad range serves all private and facility requirements. With fronts made of glass or stainless steel, the TECE push plates also enhance the high-quality bathroom.



There's a system behind it:
Every TECE push plate fits to every TECE universal cistern for front or top actuation.

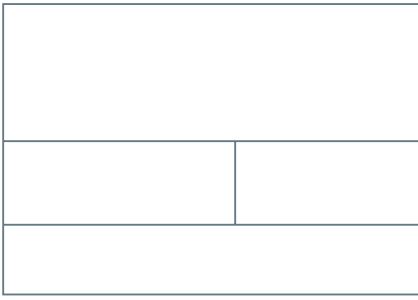

Elegance from pure stainless steel.

With its extremely flat cover, the push plate can be fully integrated in the bathroom architecture. The function is self-explanatory – one large button for full flush and a smaller one for reduced flush.

Installation in the wall is achieved with a special installation frame. Only the 2 mm thick, extremely flat stainless steel plate remains visible.

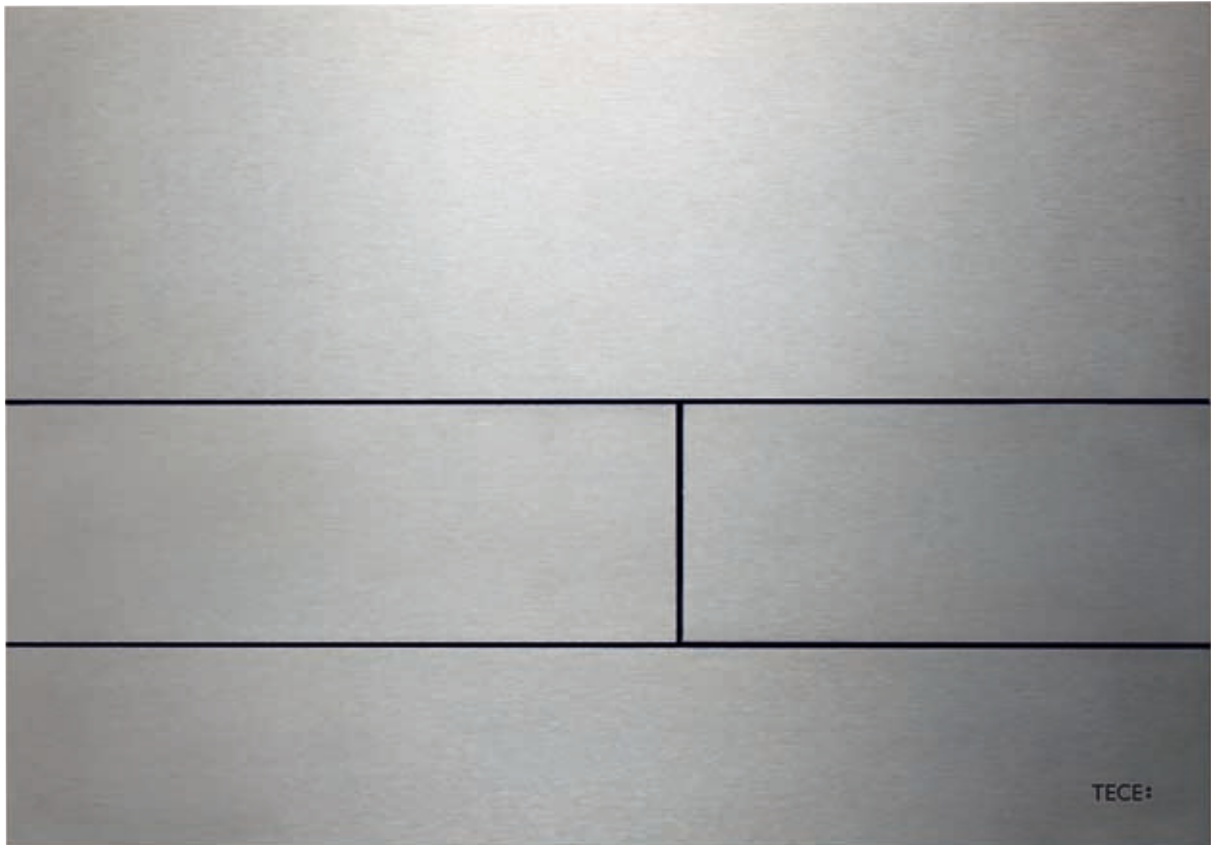

TECEsquare metal with abrasion-resistant protective layer against fingerprints.

TECEsquare metal – nominated for the Germany 2010 Design Prize and honoured with the Design Plus prize and the red dot design award.



DESIGN PLUS



reddot design award
winner 2010

TECEsquare metal

with extremely flat cover

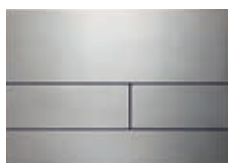

1



2



3

Toilet push plate made of metal for TECE cisterns

With two spring-mounted actuation rocker buttons for front or top actuation. Dimensions 240 x 170 x 2 mm

1	Brushed stainless steel	9.240.810
2	Bright chrome	9.240.811
3	White	9.240.812

Installation only in combination with the toilet installation frame for flush-mounted installation (Order No. 9.240.647), please order separately!

The toilet installation frame is required for **flush-mounted** installation of TECEsquare **metal**.

Toilet installation frame
Order No. 9.240.647

TECEsquare
metal



Installation
frame

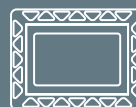

TECE cistern

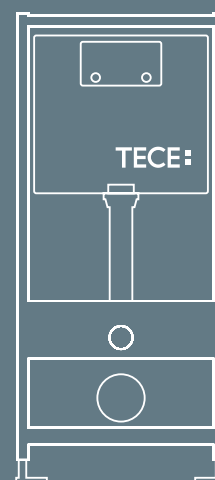

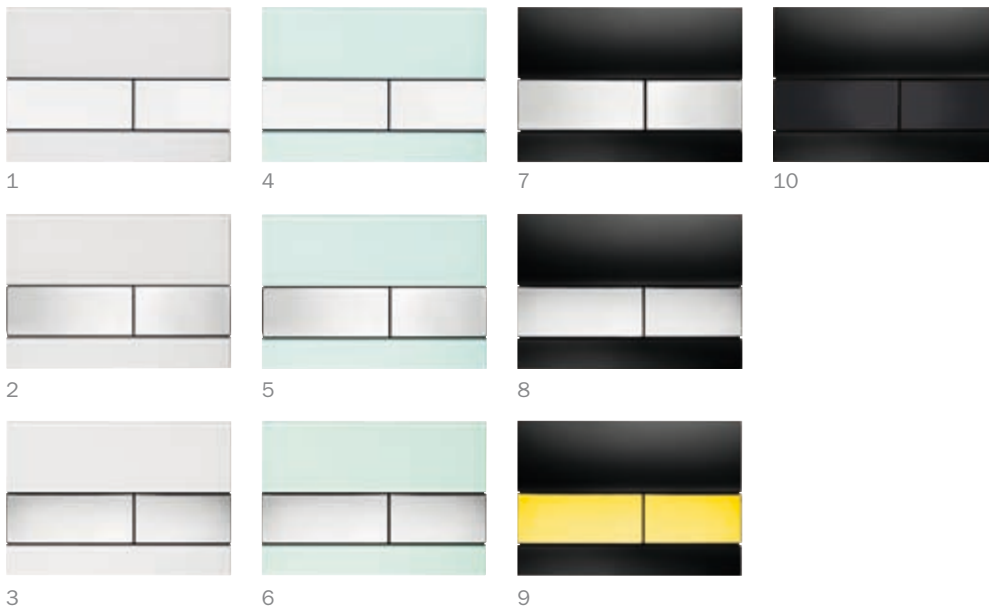

Toilet push plates made of glass for TECE cisterns

Suitable for flush-mounted installation.

For front or top actuation.

Dimensions 220 x 150 x 11 mm

1 Glass white, buttons white	9.240.800	6 Glass green, buttons bright chrome	9.240.805
2 Glass white, buttons brushed stainless steel	9.240.801	7 Glass black, buttons brushed stainless steel	9.240.806
3 Glass white, buttons bright chrome	9.240.802	8 Glass black, buttons bright chrome	9.240.807
4 Glass green, buttons white	9.240.803	9 Glass black, buttons gold	9.240.808
5 Glass green, buttons brushed stainless steel	9.240.804	10 Glass black, buttons black	9.240.809

The toilet installation frame **is required for flush-mounted installation of TECEsquare glass.**

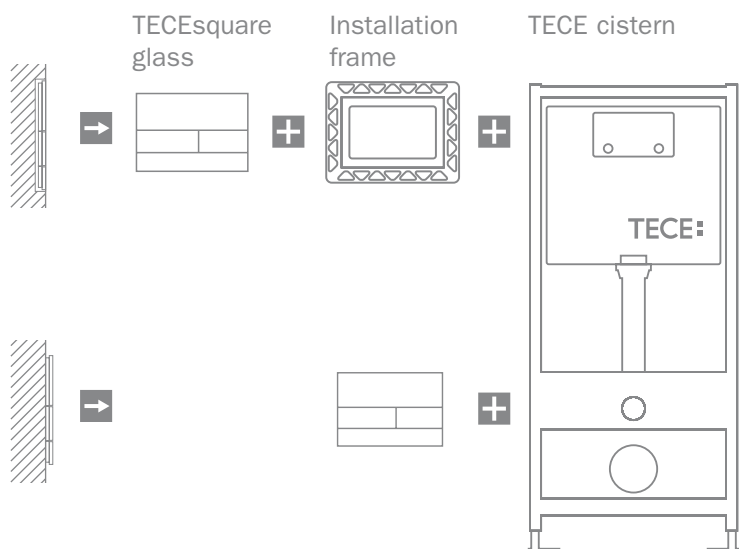

The toilet installation frame is not required for mounting the TECEsquare **glass in front of a wall.**

TECEsquare glass

with the option of flush-mounted installation

With a minimalist form, the TECEsquare glass push plate focuses on the aesthetic impact of the material. The function is self-explanatory – one large button for full flush and a smaller one for reduced flush. The plates are fixed to the wall in the conventional way or flush-mounted with a special installation frame.



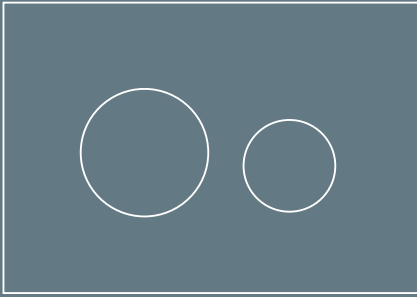

TECEloop push plates for dual flush system made of glass are reduced to a minimum in their formal appearance.

The optional flush-mounted installation of the glass flush panels is an outstanding feature of TECEloop. Using the installation set, mounting is as easy as it is precise.



TECEloop glass
with the option of flush-mounted installation

Flush installed – as though it were
part of the wall.



1



4



7



10



2



5



8



11



3



6



9

TECEloop toilet push plates glass

Toilet push plate made of glass for TECE cisterns for front or top activation.

220 x 150 x 11 mm

1	Glass white, buttons white	9.240.650
2	Glass white, buttons matte chrome	9.240.659
3	Glass white, buttons bright chrome	9.240.660
4	Glass green, buttons white	9.240.651
5	Glass green, buttons matte chrome	9.240.652
6	Glass green, buttons bright chrome	9.240.653
7	Glass black, buttons white	9.240.654
8	Glass black, buttons matte chrome	9.240.655
9	Glass black, buttons bright chrome	9.240.656
10	Glass black, buttons black	9.240.657
11	Glass black, buttons gold	9.240.658

TECEloop glass

with the option of flush-mounted installation



TECEloop urinal push plates glass

Urinal push plates made of glass for TECE pressure flushing valve housing. Including flush valve cartridge. 104 x 124 x 11 mm

12	Glass white, button white	9.242.650
13	Glass white, button matte chrome	9.242.659
14	Glass white, button bright chrome	9.242.660
15	Glass green, button white	9.242.651
16	Glass green, button matte chrome	9.242.652
17	Glass green, button bright chrome	9.242.653
18	Glass black, button white	9.242.654
19	Glass black, button matte chrome	9.242.655
20	Glass black, button bright chrome	9.242.656
21	Glass black, button black	9.242.657
22	Glass black, button gold	9.242.658

The option of flush-mounted installation is an outstanding feature of the TECEloop glass push plates for toilets and urinals.

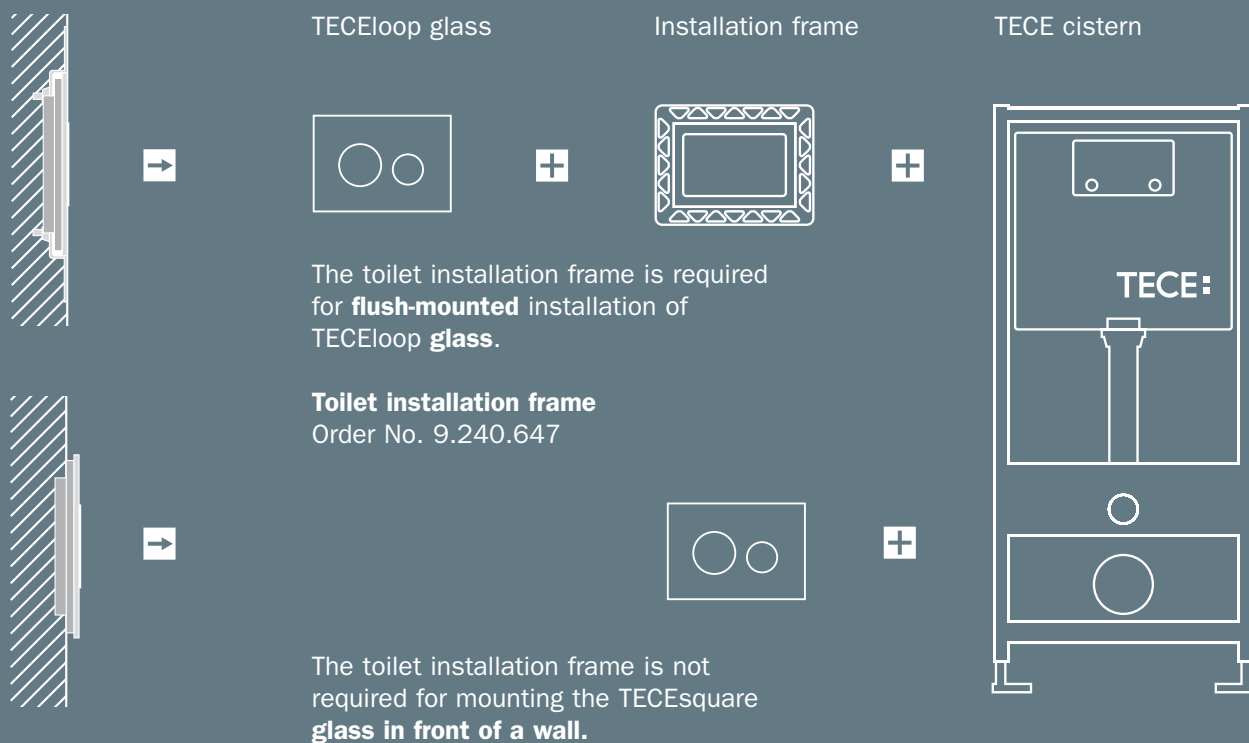

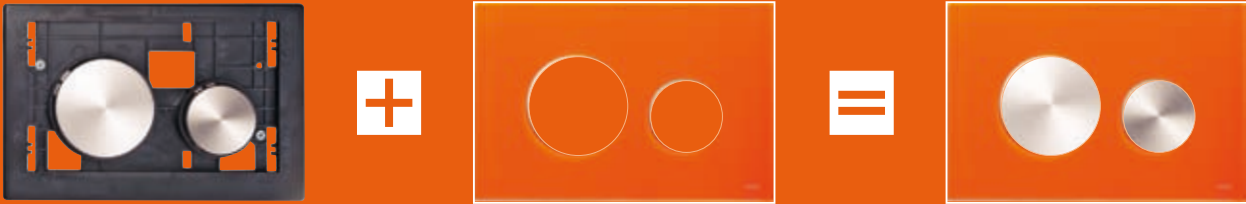

One hundred and four
possible combinations.

The TECEloop modular system consists of a standard range of 8 buttons and 13 covers. This produces a total of 104 different possible combinations.

Sophisticated technology opens up the option of flush-mounted installation of all the TECEloop glass push plates – easily and precisely with the appropriate installation frame. This is depth-adjustable for wall coverings from 5 to 18 mm, up to 36 mm even with an upgrade set.

TECEloop modular system





1



5



2



6



3



7



4



8

TECEloop buttons

1 Buttons white	9.240.663
2 Buttons white antibac	9.240.664
3 Buttons matte chrome	9.240.665
4 Buttons bright chrome	9.240.666
5 Buttons black	9.240.667
6 Buttons gold	9.240.668
7 Buttons brushed stainless steel	9.240.669
8 Buttons pergamon grey	9.240.684

The combination of buttons and push plates from the TECEloop modular system has to be ordered separately.



Photo: Alape, glass ruby red

The highlight: Some of the glass covers are colour coordinated with the products from Alape, Emco and Burgbad.

So the bathroom planner always has the right toilet push plate at hand.

TECEloop modular system

TECEloop covers

9	Glass cover mint green	9.240.670
10	Glass cover white, Emco	9.240.671
11	Glass cover asis green, Emco	9.240.672
12	Glass cover orange	9.240.673
13	Glass cover black, Alape and Emco	9.240.674
14	Cover slate slab	9.240.675
15	Glass cover silvery-grey, Alape	9.240.676
16	Glass cover blue-grey	9.240.677
17	Glass cover coffee brown	9.240.678
18	Glass cover ruby red, Alape	9.240.679
19	Glass cover ivory, Alape	9.240.680
20	Glass cover grass green, Burgbad	9.240.685
21	Mirror cover	9.240.683

Accessories

Installation frame for flush-mounted installation of TECEloop, Order No. 9.240.649 (without illustration)

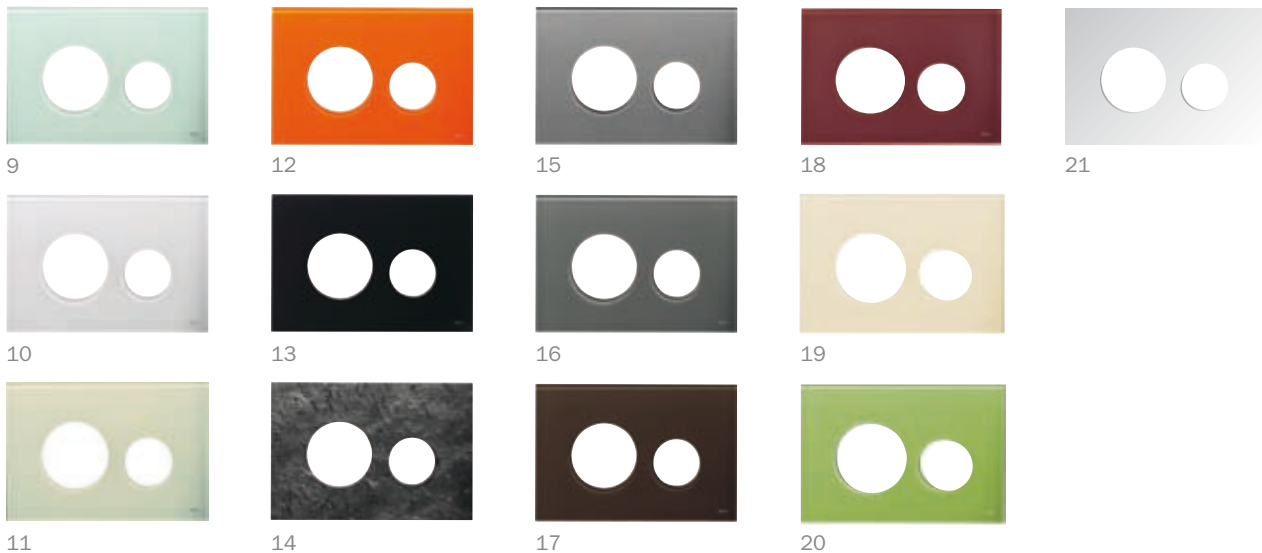

Internet configurator for TECE push plates

Visit us on our website at www.tece.de. Here you can use our configurator to easily and conveniently look for the right push plate for your personal bathroom.



1/3



4



5



2



5

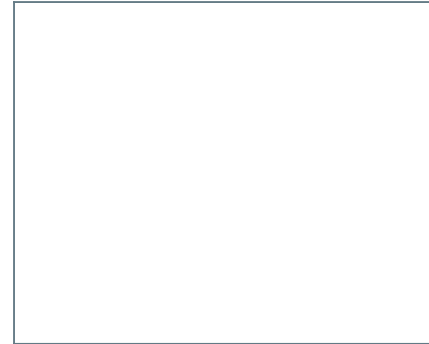

TECEloop toilet push plates plastic

Toilet push plate made of plastic. 216 x 145 x 6 mm

1 White	9.240.600
2 White, buttons bright chrome	9.240.627
3 White antibac	9.240.640
4 Pergamon grey	9.240.601
5 Matte chrome	9.240.625
6 Bright chrome	9.240.626



7/9



11



8



12



10

TECEloop urinal push plates plastic

Urinal push plates made of plastic. 100 x 120 x 6 mm

7 White	9.242.600
8 White, button bright chrome	9.242.627
9 White antibac	9.242.640
10 Pergamon grey	9.242.601
11 Matte chrome	9.242.625
12 Bright chrome	9.242.626

One design –
for toilet and urinal.



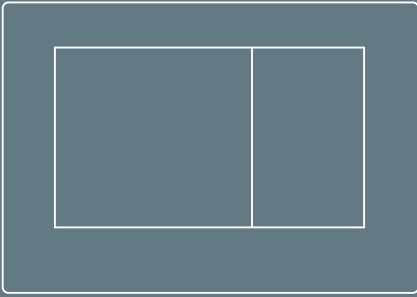

The TECEplanus push plate made of stainless steel is robust and especially vandalproof. A concealed screw further protects it against theft.

So they are particularly suitable for public sanitary areas, restaurants or hotels. Their especially compact dimensions and elegant design harmonise with any mood.

For people who sometimes like
to hit the buttons.

TECEplanus stainless steel





1

5



2

6



9/12



3

7



10/13



4

8



11/14



15

19/23



16

20/24



17

21/25



18

22/26

* Not compatible with 8 cm cistern

TECEplanus toilet push plates

Toilet push plate made of stainless steel for TECE cisterns for front or top actuation. Rubber buffered stop on both sides. 214 x 144 x 15 mm

Toilet push plates dual flush system

1 White, silk-mat	9.240.322
2 White shiny	9.240.324
3 Brushed stainless steel	9.240.320
4 Bright chrome	9.240.321

Toilet push plates single flush system

5 White, silk-mat	9.240.312
6 White shiny	9.240.314
7 Brushed stainless steel	9.240.310
8 Bright chrome	9.240.311

Toilet electronics with IR sensor, 6 V battery

9 White shiny	9.240.361
10 Brushed stainless steel	9.240.350
11 Bright chrome	9.240.351

Toilet electronics with IR sensor, 230 /12 V mains

12 White shiny	9.240.362
13 Brushed stainless steel	9.240.352
14 Bright chrome	9.240.353

TECEplanus urinal push plates

Urinal push plate made of stainless steel for TECE flushing valve housing. Including flush valve cartridge. 100 x 120 x 15 mm

Urinal push plates

15 White, silk-mat	9.242.312
16 White shiny	9.242.314
17 Brushed stainless steel	9.242.310
18 Bright chrome	9.242.311

Urinal electronics with IR sensor, 6 V battery

19 White, silk-mat	9.242.354
20 White shiny	9.242.356
21 Brushed stainless steel	9.242.350
22 Bright chrome	9.242.351

Urinal electronics with IR sensor, 230 /12 V mains

23 White, silk-mat	9.242.355
24 White shiny	9.242.357
25 Brushed stainless steel	9.242.352
26 Bright chrome	9.242.353

TECEplanus

urinal electronics, toilet electronics with IR sensor

Toilet electronics

TECEplanus toilet electronics with IR sensor – contactless automatic flushing ensures reliable recognition of standing or sitting persons. Manual actuation is also possible. The power supply is from a battery or the mains.

- Operation via a 6 V battery or via an external 230 Volt/12 Volt transformer
- Thanks to lithium batteries power for approx. 25 000 flushes



TECE urinal push plates with flush valve technology from TECE

- Same flush valve housing for the use of manual or electronic cartridges
- Different flushing volumes can be set
- Plastic piston seal
- A universal module for electronic and manual actuation
- Simple to assemble cartridge and electronics despite the small push plate

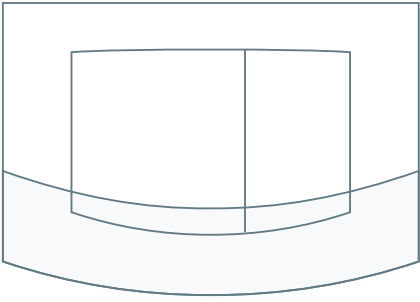

The classic from TECE.

TECEambia push plates, with their single or dual flush system, are the universal plastic standard.

Available in numerous variations, their compact dimensions fit harmoniously in every bathroom environment.

Double-sided rubber buffers reliably prevent rattling noises.

In the antibacterial version of TECEambia, the growth of germs on the surface is inhibited by silver ions – ideal for public sanitary areas.



- All plates can be used for front or top actuation
- The timeless neutral shape is suitable for every bathroom mood
- Trendy small dimensions
- Double-sided rubber buffers prevent unpleasant rattling noises
- Robust actuation mechanism

TECEambia plastic



* Also available with antibacterial action

TECEambia toilet push plates

Toilet push plate made of glass for TECE cisterns for front or top actuation. Stop buffered with rubber on both sides. 214 x 152 x 22 mm

Toilet push plates for dual flush system

1 White	9.240.200
2 White antibac	9.240.240
3 Pergamon grey	9.240.201
4 Matte chrome	9.240.225
5 Bright chrome	9.240.226
6 Frame matte chrome, buttons bright chrome	9.240.253
7 Frame bright chrome, buttons matte chrome	9.240.254

Toilet push plates for single flush system

8 White	9.240.100
9 White antibac	9.240.140
10 Pergamon grey	9.240.101
11 Matte chrome	9.240.125
12 Bright chrome	9.240.126

TECEambia urinal push plates

Urinal push plate made of plastic for TECE pressure flushing valve housing. Including flush valve cartridge. 100 x 120 x 15 mm

Urinal push plates

13 White	9.242.100
14 White antibac	9.242.140
15 Pergamon grey	9.242.101
16 Bright chrome	9.242.126

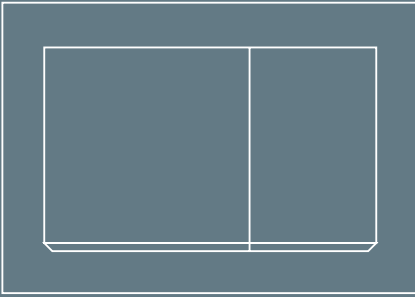

The standard toilet push plate in square design.

Use of this new plastic push plate is sure to be of particular interest in standard areas and facilities. TECEbase has a dual flush function.

The narrow button actuates a reduced flush, the wide button a full flush. Like all toilet push plates from TECE, its dimensions are relatively small and it fits the TECE actuation concept for all TECE cistern models.

Good design – also in the
standard bathroom.

TECEbase

made of plastic



1



2



3

TECEbase toilet push plates for dual flush system

Toilet push plate made of glass for front or top actuation.
214 x 145 x 18 mm

1 White	9.240.700
2 Bright chrome	9.240.701
3 Matte chrome	9.240.702



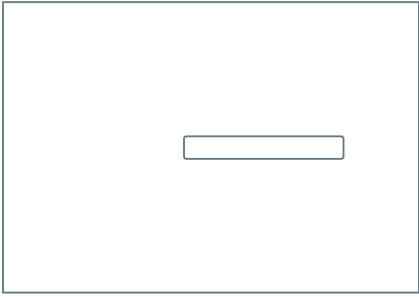

Toilet flush handles

TECE flushing technology – the flush handle with a rotary mechanism. Why should attractive bathroom design stop when it comes to the toilet push plate?

The rotary mechanism developed by TECE makes it possible to match toilet push plates with the design of high-quality handle series for the first time. These are offered by renowned manufacturers.



The flush handle matches the design of the respective handle series.
Fig. Dornbracht MEM

Don't press – turn ...

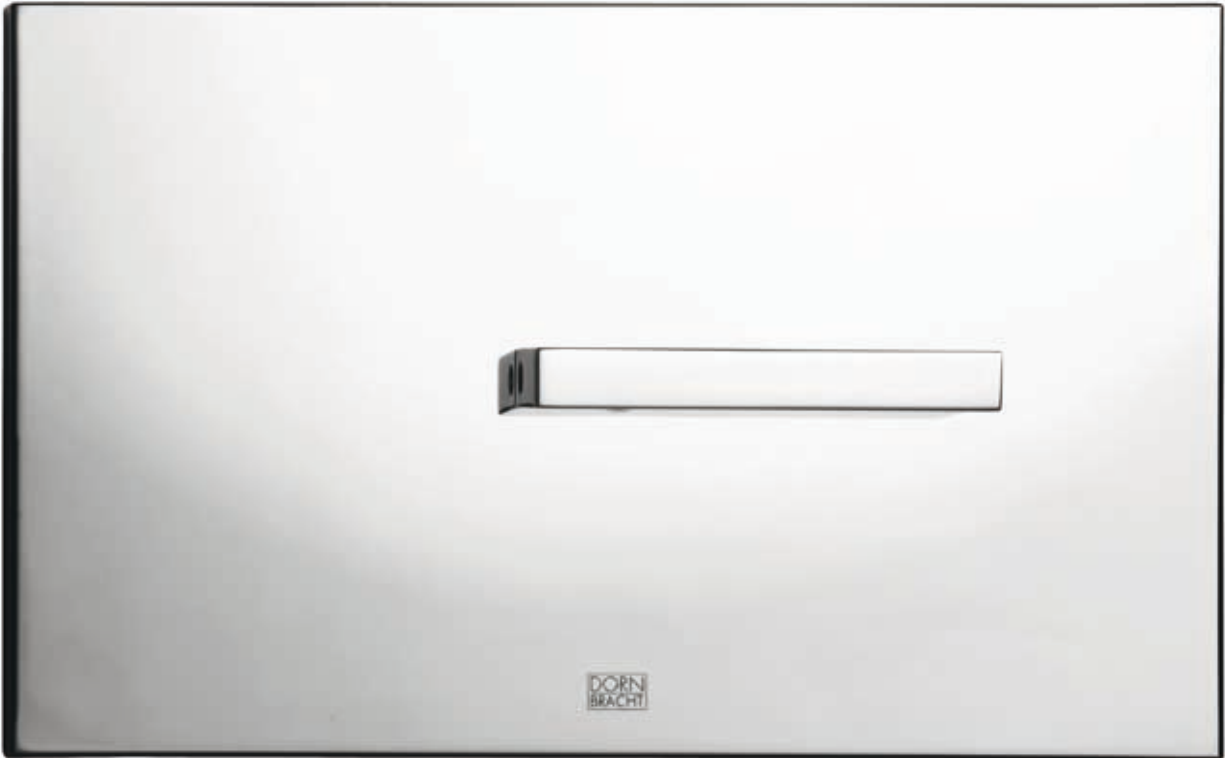

All flush handles operate like a superior bathroom fitting with high-quality ease of operation – **don't press – turn**. For the first time, it is possible to operate the dual flush function using a single control element.

Toilet flush handles are offered from a range of manufacturers to match the TECE universal cistern.

Flush handles



Company: Jado
Series: Lighthouse



Company: Jado
Series: Glance, Geometry, IQ



Company: Emco
applicable for all series



Company: Emco
applicable for all series



Company: International Bathrooms
Series: St. James Collection



Company: Kludi
Series: Amphora



Company: Kludi
Series: JOOP



Company: SAM
Series: Way



Company: Oras
Series: Il Bagno Alessi by Oras



Company: Hansa
Series: Designo



Company: Hansa
Series: Murano



Company: Dornbracht
applicable for all series

TECE flush handle partners:



The right frame for flush-mounted installation.

Flush-mounted installation of TECESquare and TECEloop glass

With a toilet and urinal push plate that is fitted completely level with the wall, TECEloop and TECESquare offer the ultimate in technical perfection and structural fascination. Its depth-adjustable installation frame ensures that it is as easy as ever possible to install. The high-quality glass surface fits elegantly and unobtrusively into the bathroom structure.

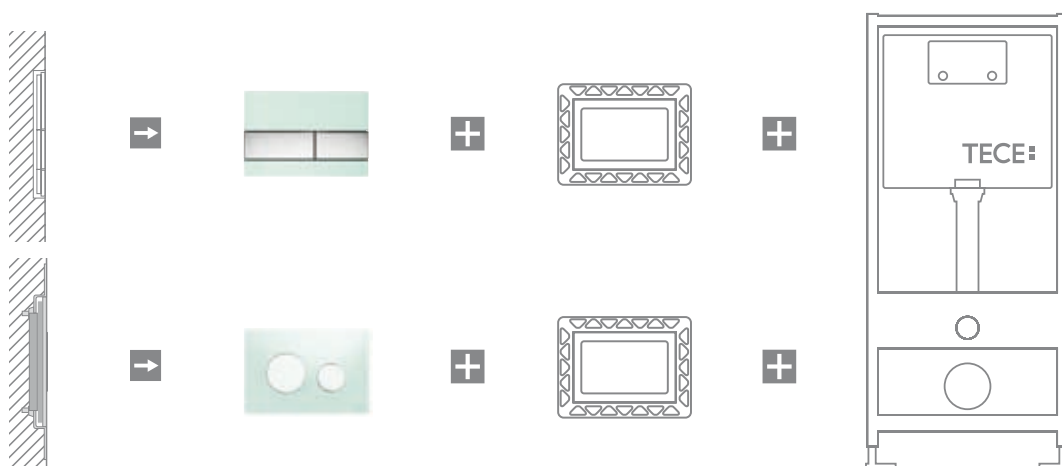

Toilet installation frame for flush-mounted installation of TECESquare and TECEloop glass push plates or for mounting TECESquare metal

The toilet installation frame can be used in combination with the TECEprofil modules for dry-wall construction. In a brick curtain wall, flush-mounted installation is achieved with the TECEbox brick-wall modules and with brick-wall protection for flush-mounted installation (Order No. 9.030.029).

Toilet installation frame

Depth-adjustable for wall coverings from 5 to 18 mm (up to 36 mm with upgrade set). The different frame colours allow individual modification in line with the cover or wall.

White	9.240.646
Black	9.240.647
Gold-plated	9.240.648
Bright chrome	9.240.649

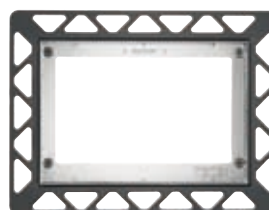

Urinal installation frame

For flush-mounted installation of the TECEloop glass push plates. Installation frame depth-adjustable for wall coverings from 5 to 18 mm (up to 36 mm with upgrade set).

Note: Only for dry-wall construction.

White	9.242.646
Black	9.242.647
Gold-plated	9.242.648
Bright chrome	9.242.649



The technology behind ...

The cistern for all toilet push plates from TECE

For years, the TECE cisterns have been proven millions of times in practice. The newly developed drain valve inside the cistern was awarded the Design Plus prize for sustainable water use. It permits a real 4.5 litre short flush even with the use of dual flush system. For installation, the cistern is delivered as a TECEprofil module for dry-wall construction or as a TECEbox for brick-wall construction.

Modules for brick and dry wall construction - for toilet and urinal.

The modules shown here represent just a small selection of the entire TECE range. The TECEprofil range offers modules with various assembly heights and special modules for all application areas, e.g. for odour extraction or for installation of barrier-free toilets. Modules for installing washlets from TOTO are new.



TECEprofil toilet module with TECE cistern, assembly height 1120 mm, for installation in a TECEprofil curtain wall, front actuation.



TECEprofil toilet module with TECE cistern, assembly height 820 mm, for installation in a TECEprofil curtain wall, front and top actuation.



TECEprofil urinal module with TECE flush valve housing, for installation in a TECEprofil curtain wall, to take manual and electronic actuation systems.



TECEbox brick-wall construction cistern, assembly height 1060 mm, for installation in a bricked curtain wall in front of a solid wall front actuation.

The 8 cm concealed cistern

The 8 cm concealed cistern is extremely flat and thus ideal for installation in thin masonry. The construction is based on German know-how and is the product of many years of experience of TECE in the field of flushing technology. For installation the cistern is delivered as a TECEprofil module for dry-wall construction or TECEbox for brick-wall construction.

**One argument alone speaks in favour of TECE cistern:
The wide range of push plates.**

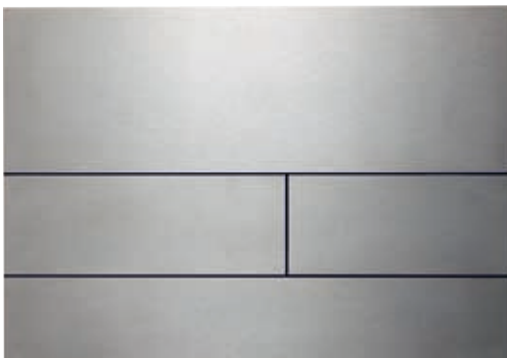

One of many: TECEsquare push plates.



Installation variants

TECEbox brick wall cisterns and TECEprofil module

The 8 cm toilet module range comprises four mounting variants for all conventional mounting situations. All these modules use the 8 cm cistern from TECE. It is pre-mounted and sealed, has a 9.5 litre flushing volume, is insulated against condensate water and fitted with a water-saving dual flush system (3 litres reduced flushing volume – 4.5/6/9 litres full flushing volume).

The cistern is compatible with all TECE push plates (TECESquare, TECEloop, TECEplanus (without toilet electronics), TECEambia, TECEbase and toilet flush handles) and can be used as single flush or dual flush cistern depending on the push plate.



**Brick-wall cistern
TECEbox basic**
for floor-standing toilets



**Brick-wall cistern
TECEbox**
for wall-hung toilets



**Brick-wall cistern
TECEbox plus**
for wall-hung toilets,
sound-suppressed



TECEprofil toilet module
to be mounted in metal
and wooden frame walls
or in front of solid walls



TECESquare/
TECEloop glass



TECESquare
metal

! A minimum finish or facing thickness of 3 cm is needed for the flush mounting of TECESquare glass and TECEloop glass and for the mounting of TECESquare metal!

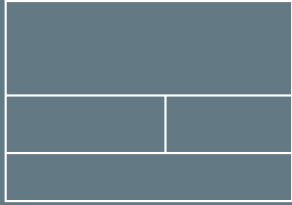

TECEsquare

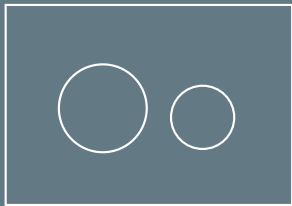

TECEloop

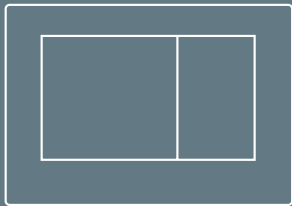

TECEplanus

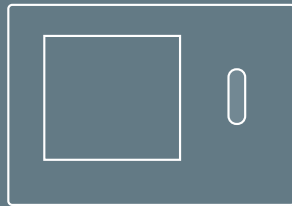

TECEplanus with IR-Sensor
(Not compatible with 8 cm cistern)

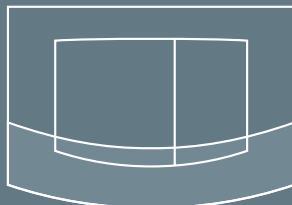

TECEambia

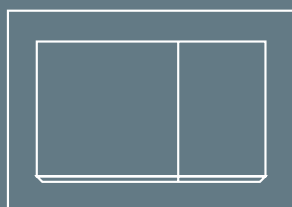

TECEbase

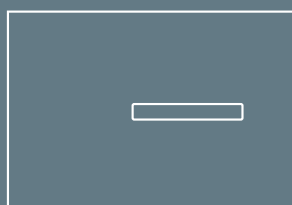

Toilet flush handle

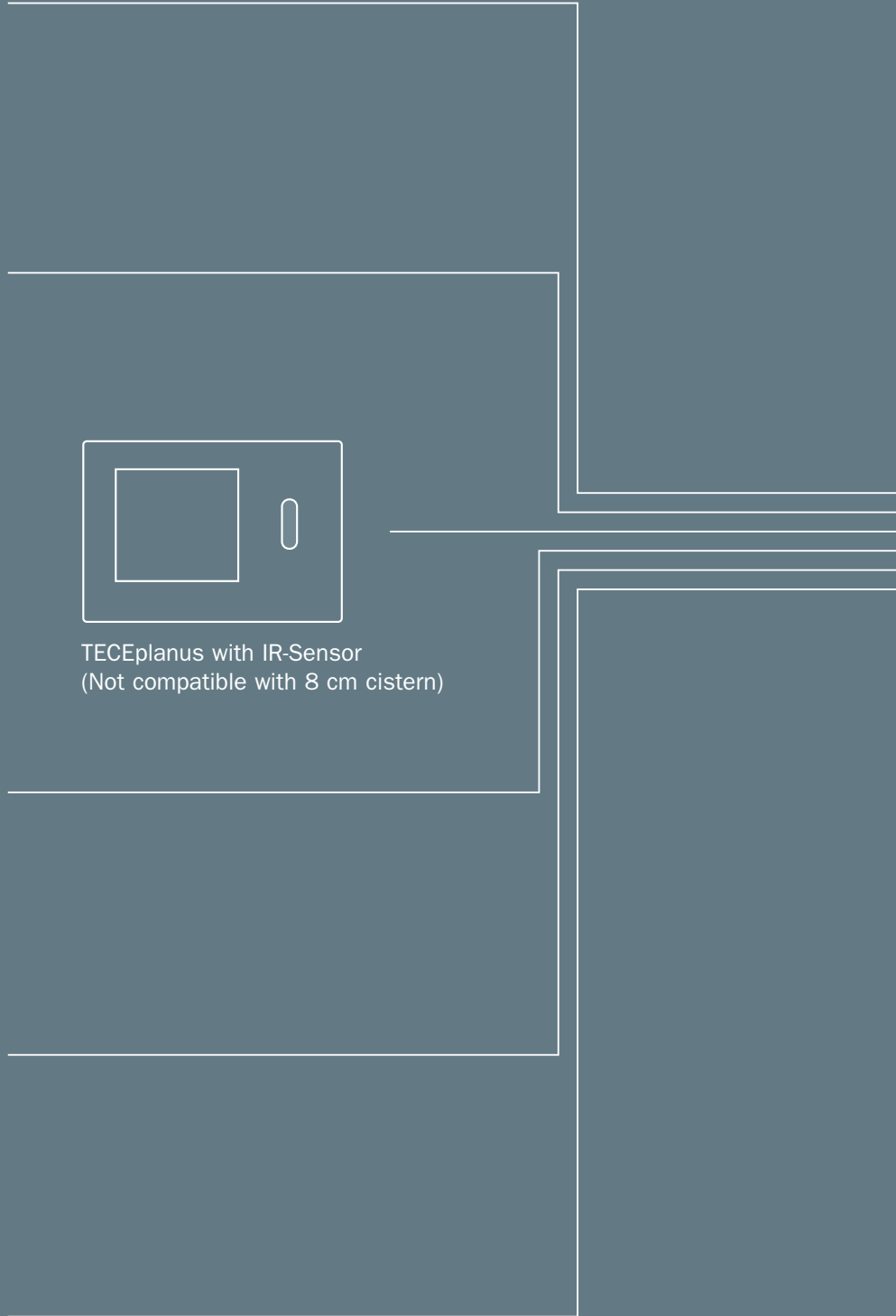

There's a system behind it – flushing technology from TECE.

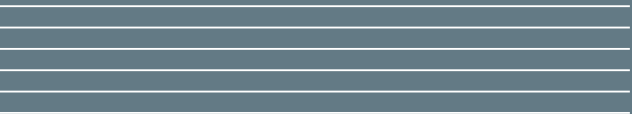

TECE cisterns and TECE push plates are always compatible with one another!
Selection of the right toilet push plate is really not that easy with some cistern manufacturers. Even if the push plate and cistern come from the same manufacturer, it certainly still does not mean that they fit together. It's different with TECE – here the selection of the right toilet push plate is no problem.

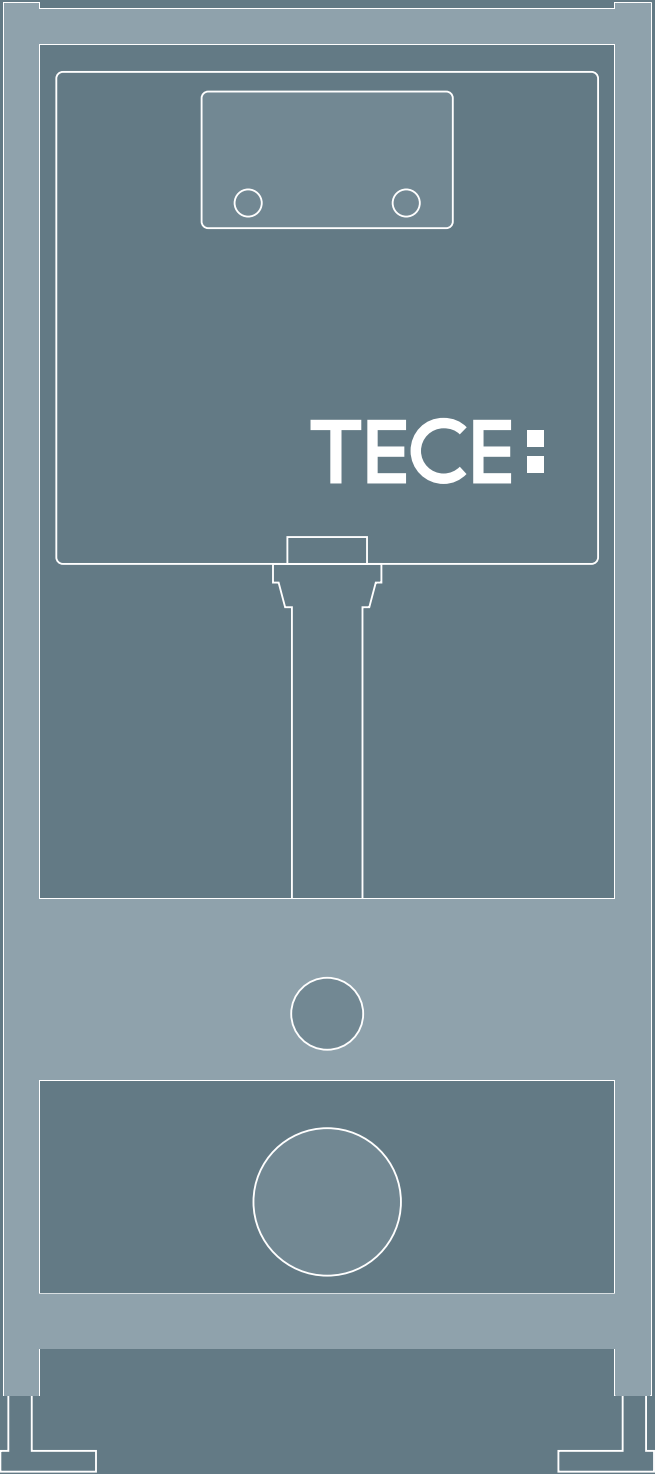

Toilet module

Flushing technology with a system – made by TECE.

All toilet push plates from TECE are
also suitable for top actuation.

Internet configurator for TECE push plates

Visit us on our website at www.tece.de. Here you can
use our configurator to easily and conveniently look for
the right push plate for your personal bathroom.

TECE GmbH

International Business

Hollefeldstraße 57
48282 Emsdetten
Germany

Phone +49 (0) 25 72 / 928 999

Fax +49 (0) 25 72 / 928 204

international-business@tece.de

www.tece.biz



DS030 002 12 a